

1. Dimension & Accessories

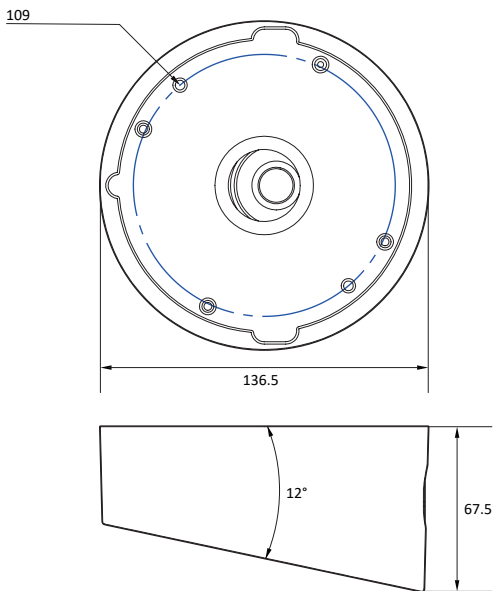

Junction Bracket
Screw - 2pcs



Gang Plate
Screw - 3pcs



Screw &
Plastic Anchor - 3pcs

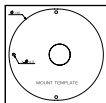

Mount Template